

Assembly instruction

Double Decker

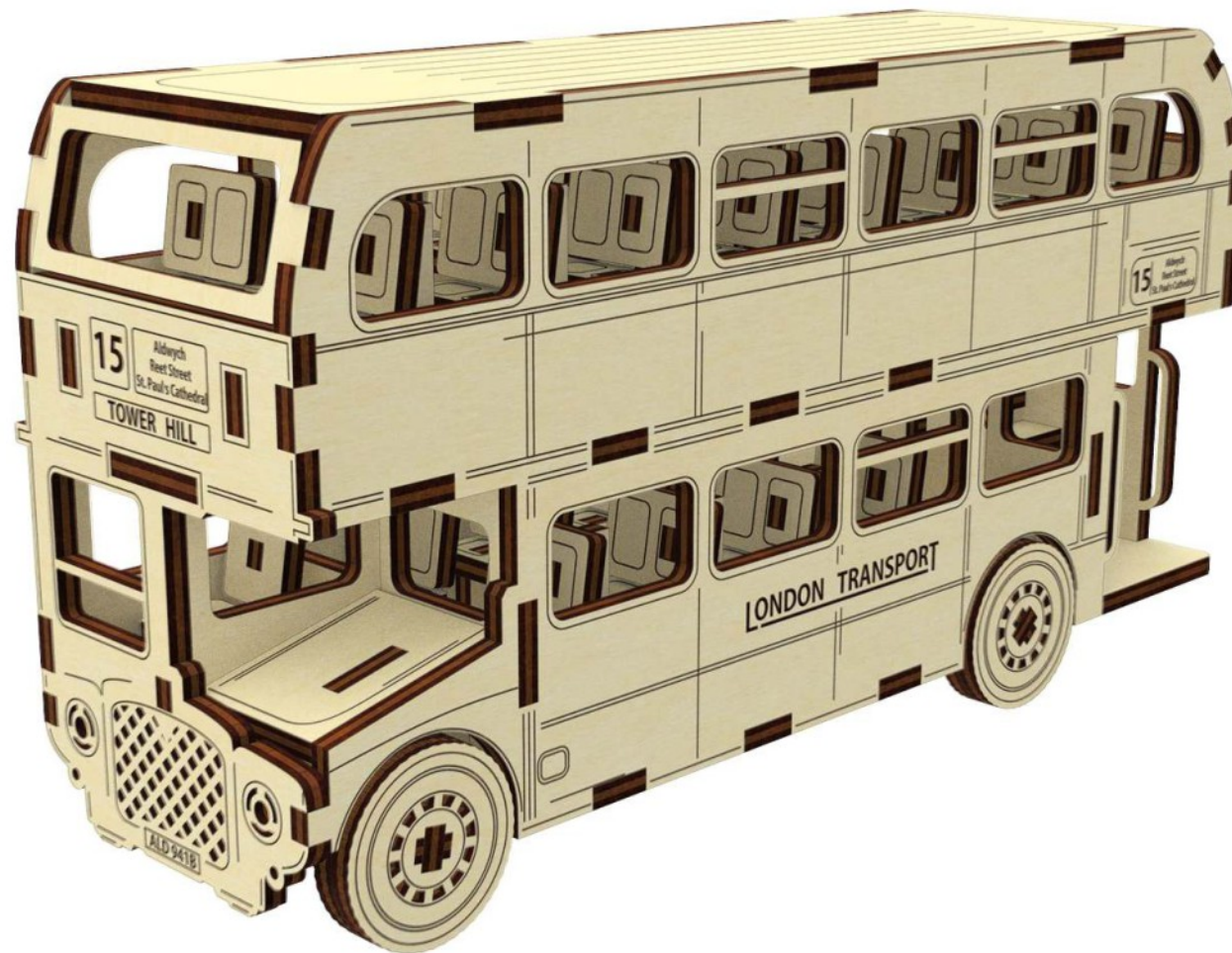

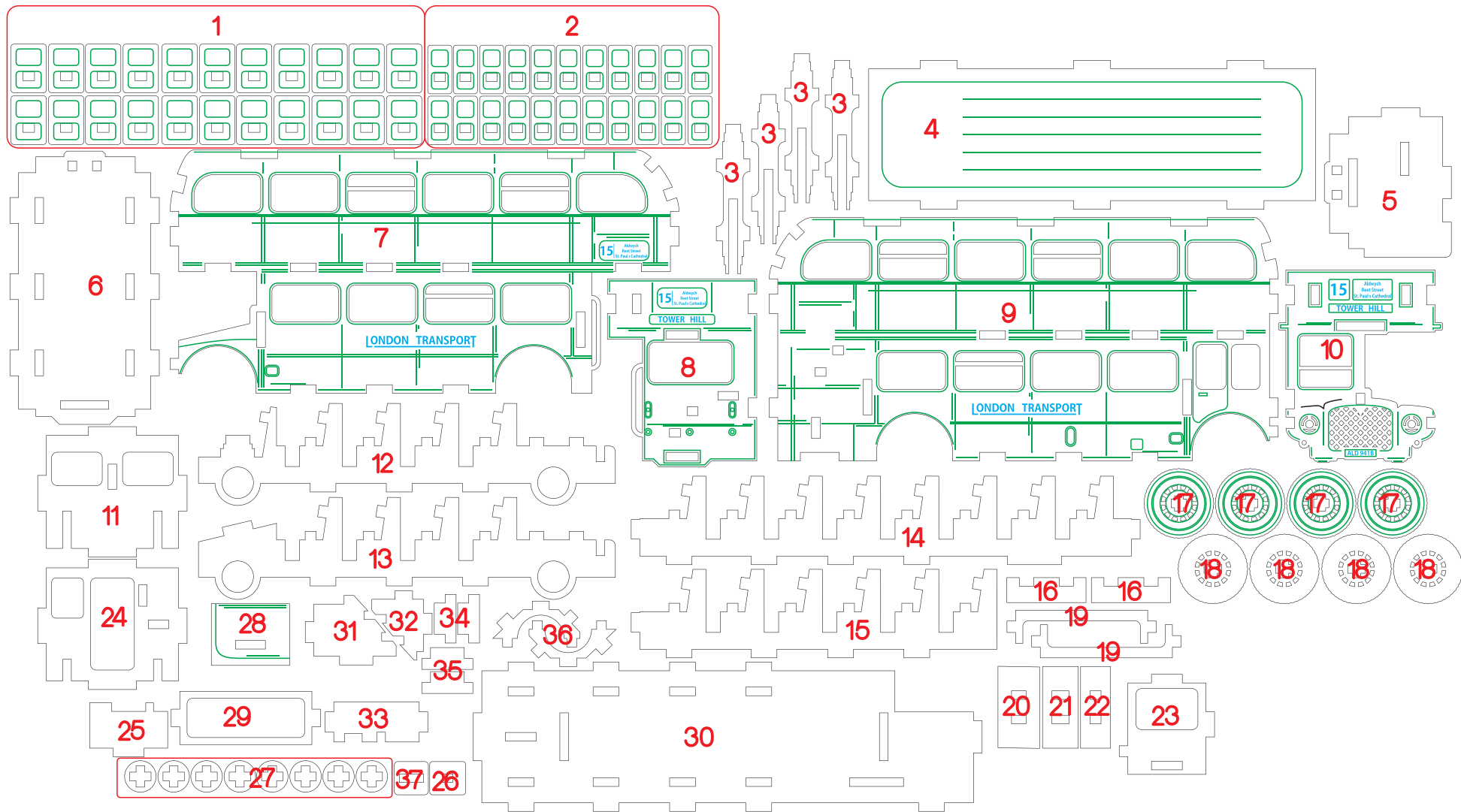

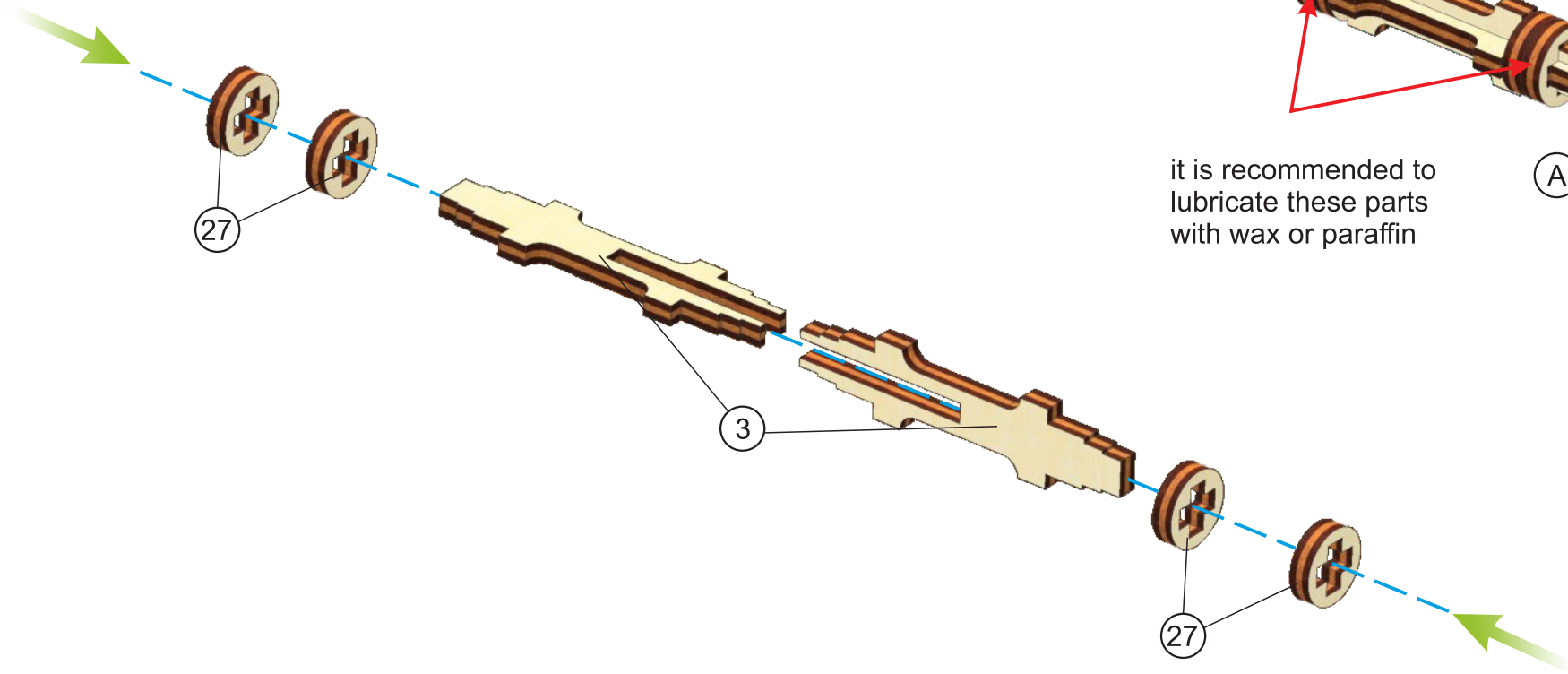

it is recommended to lubricate these parts with wax or paraffin

(A)

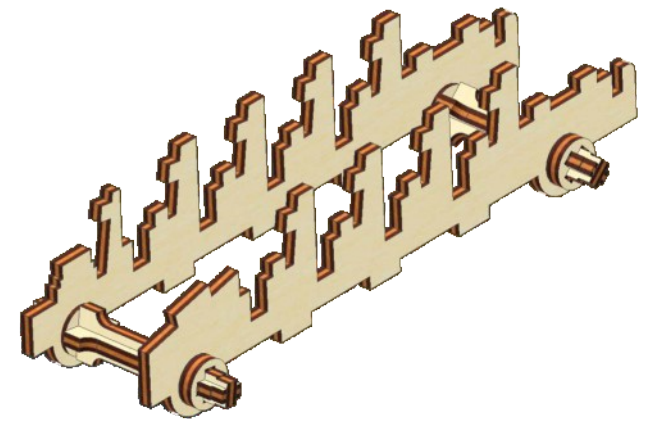
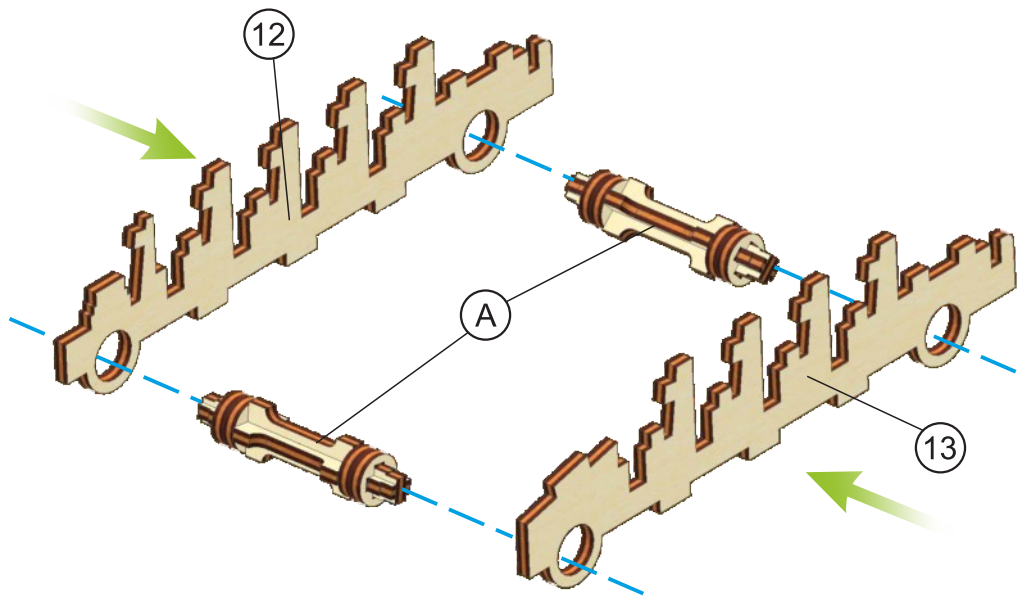

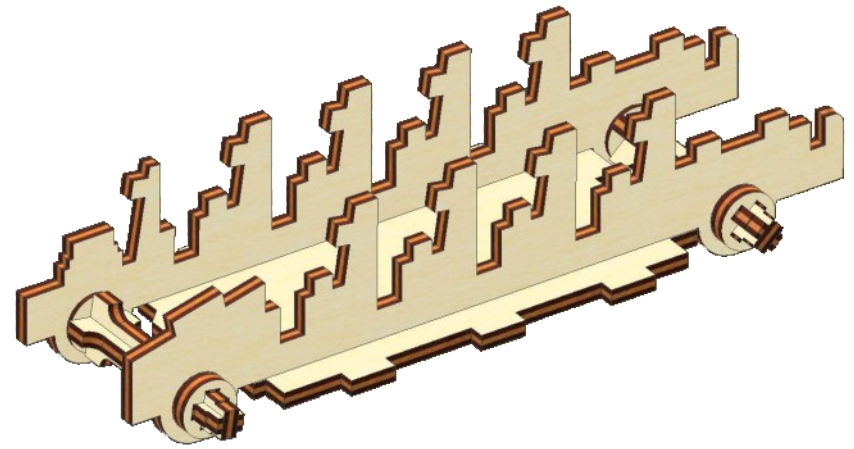
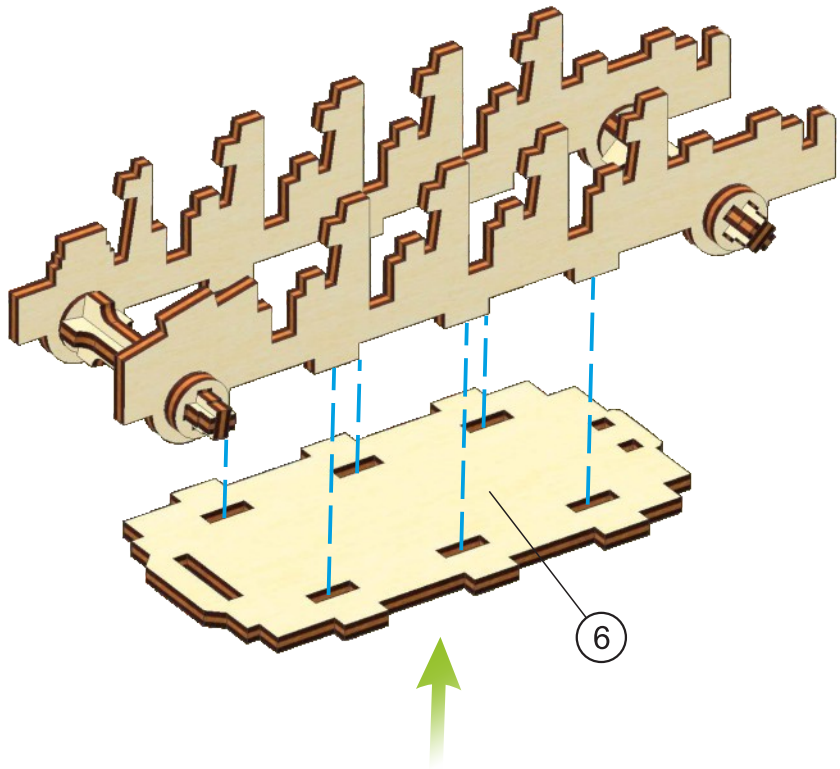

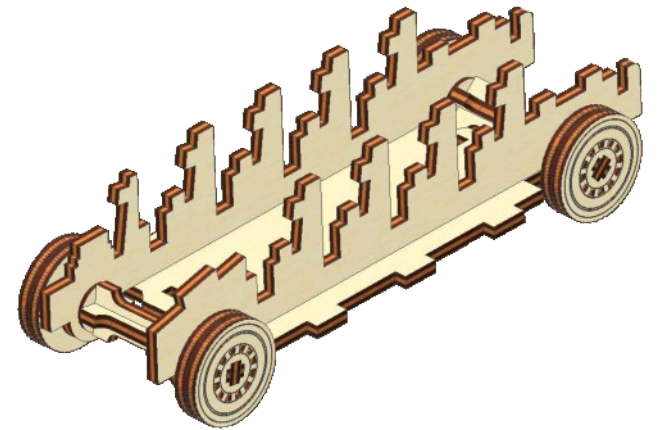
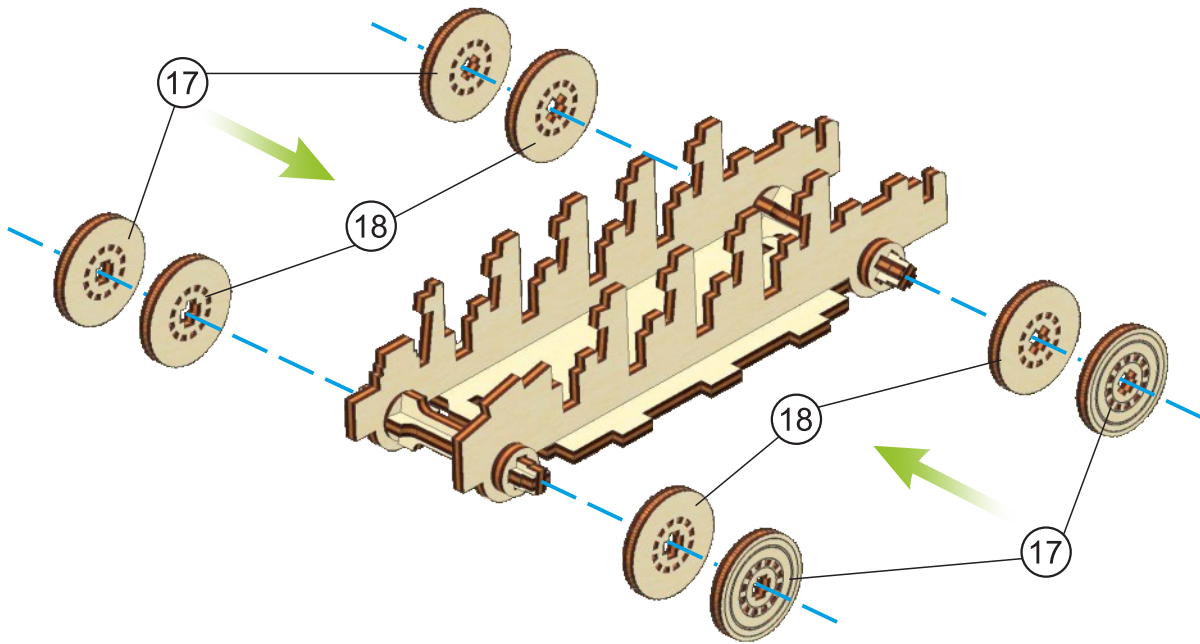

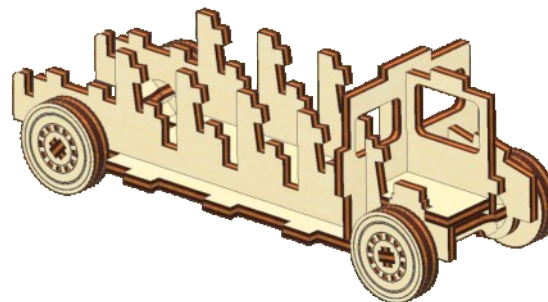
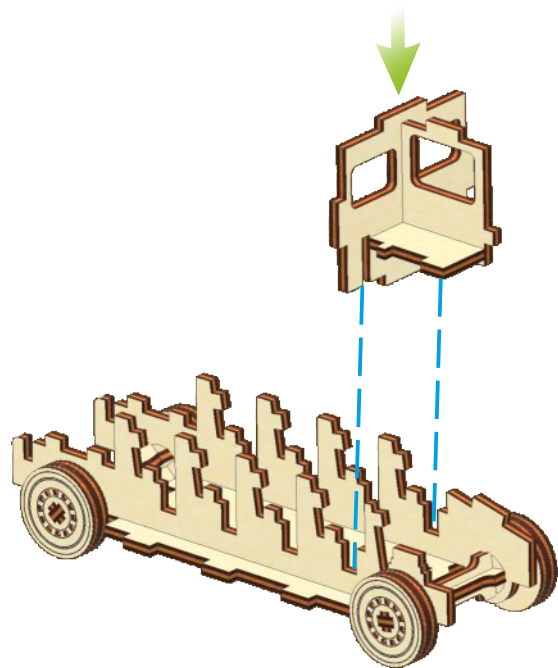
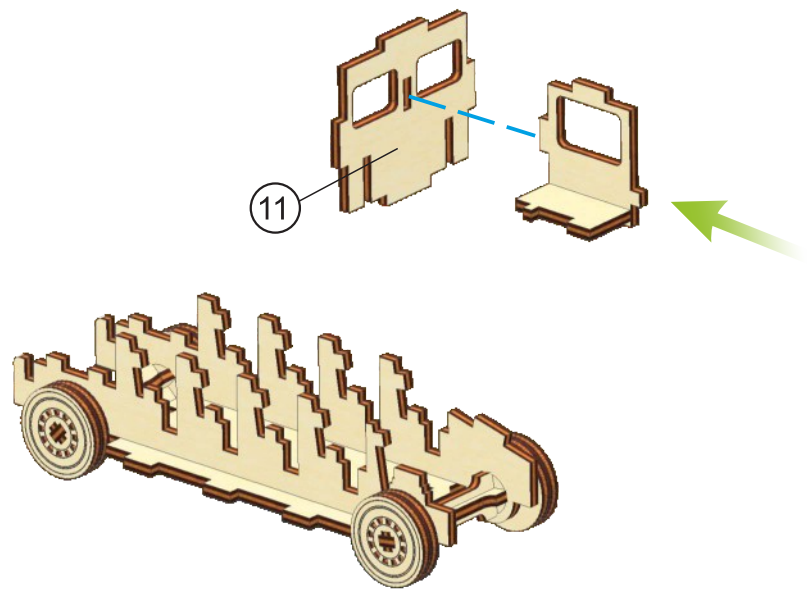
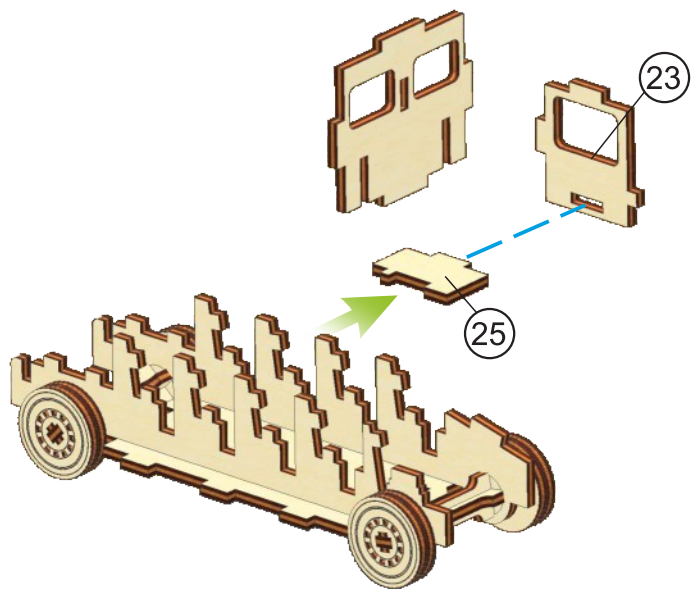

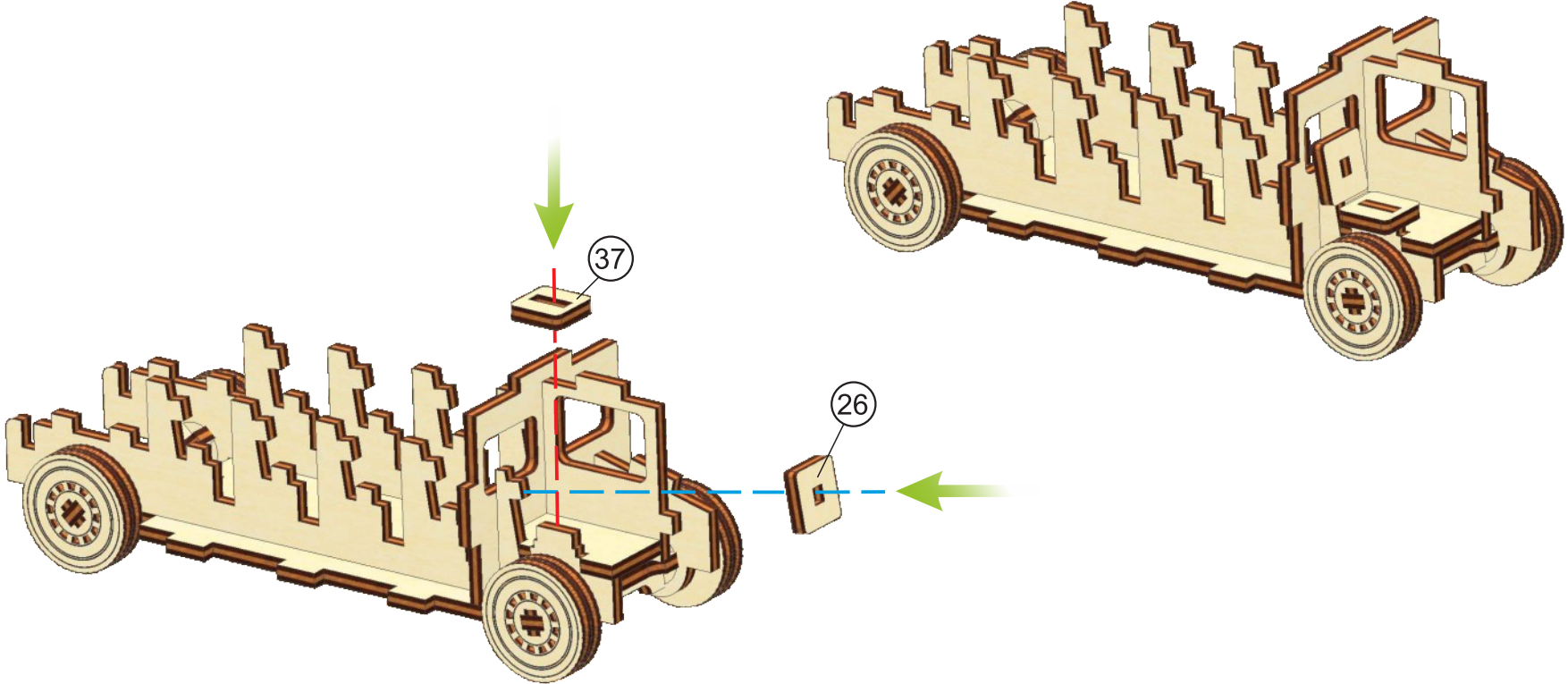

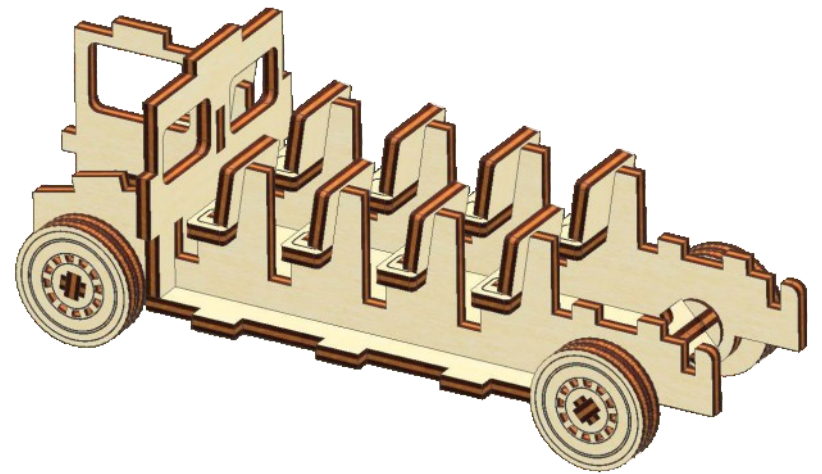
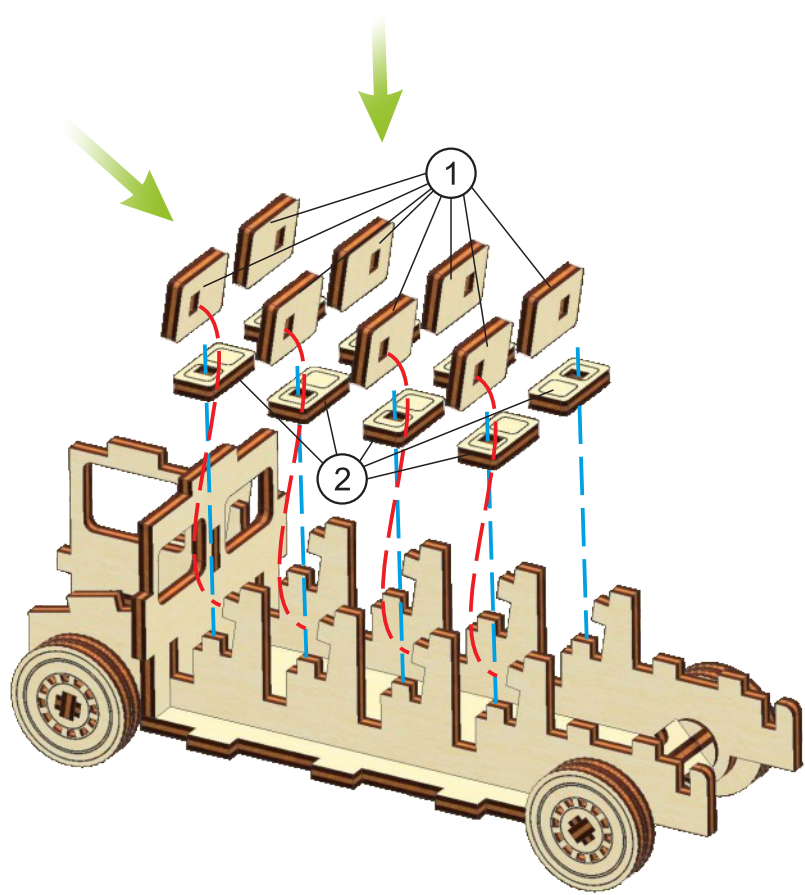

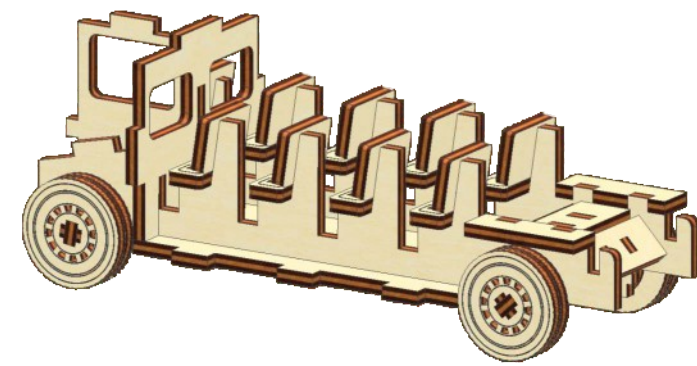
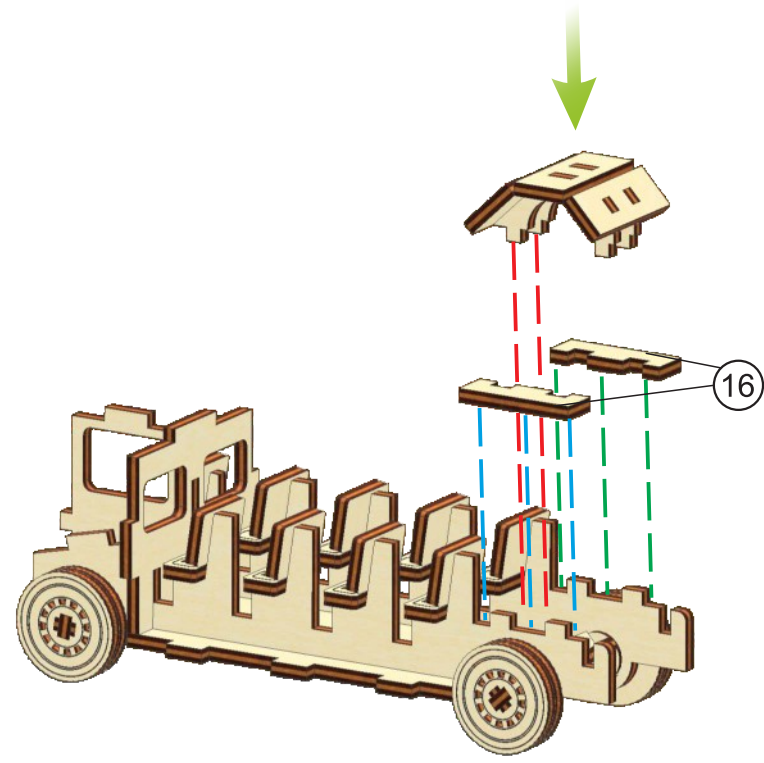
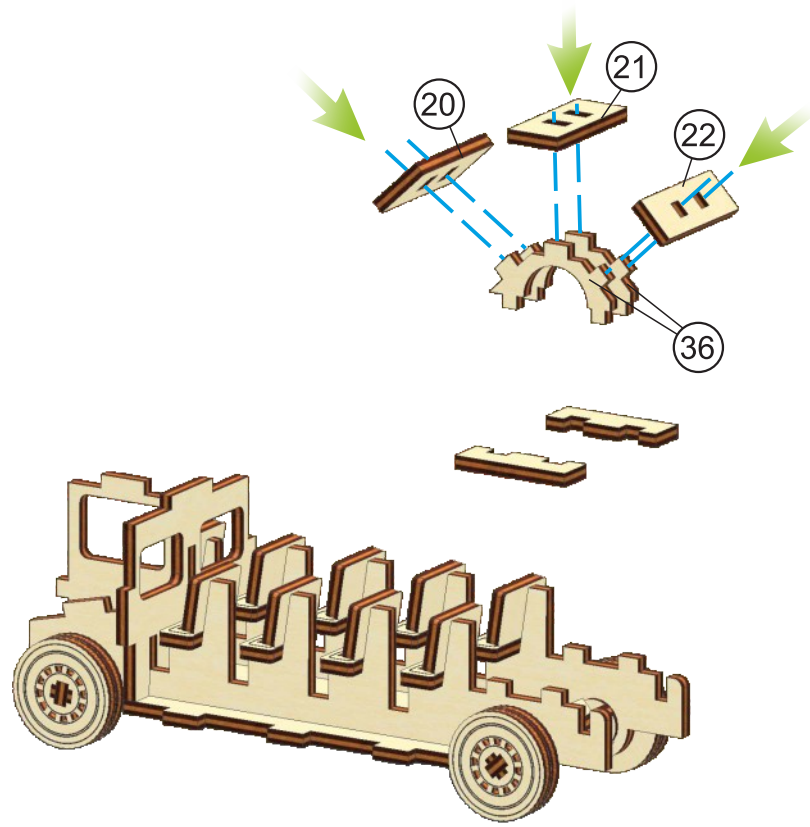

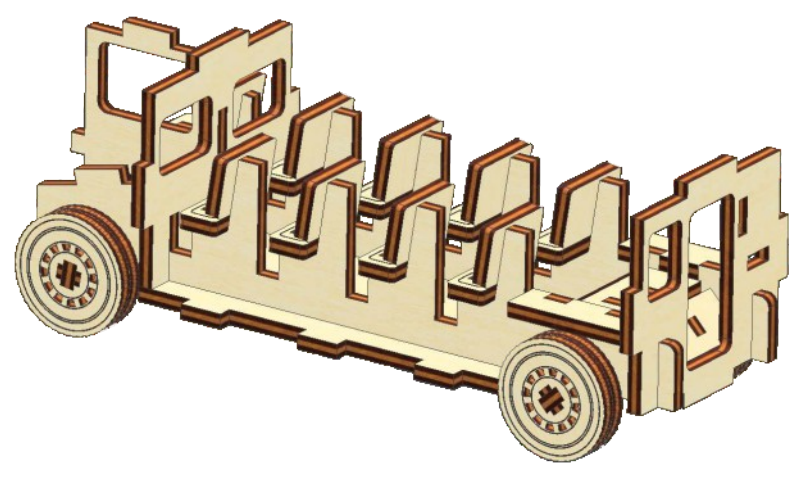
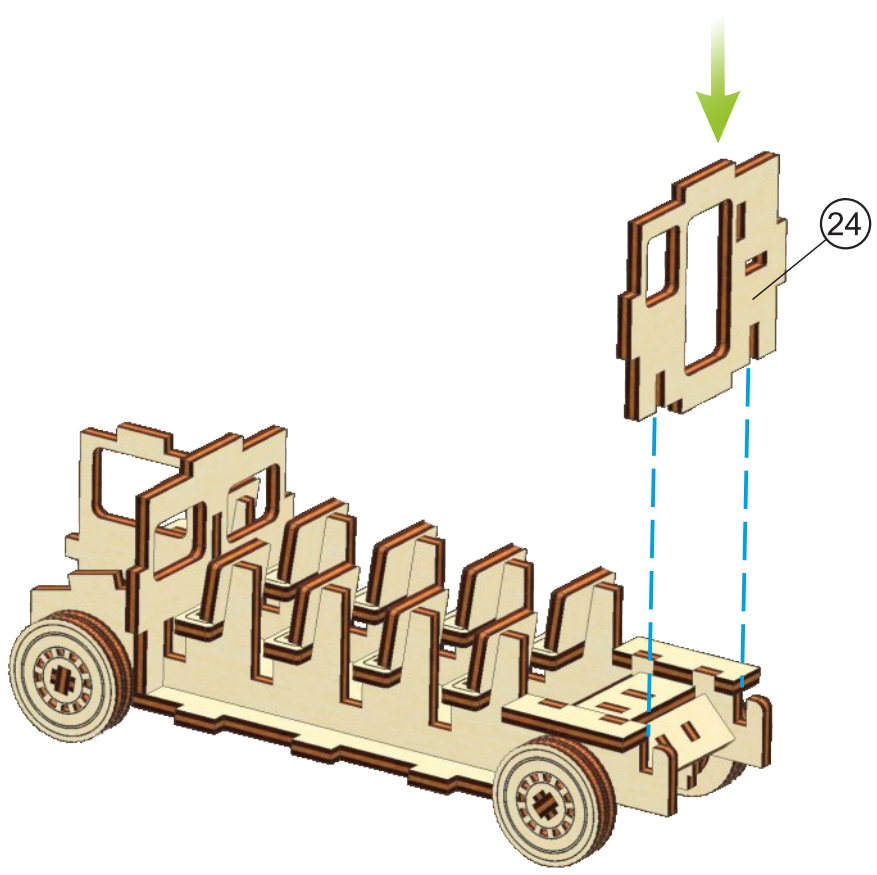

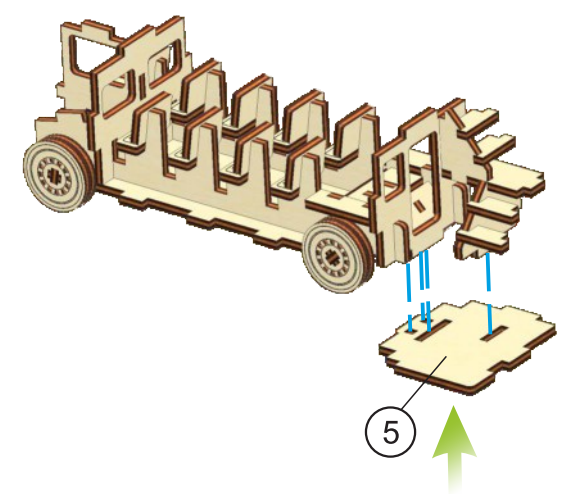
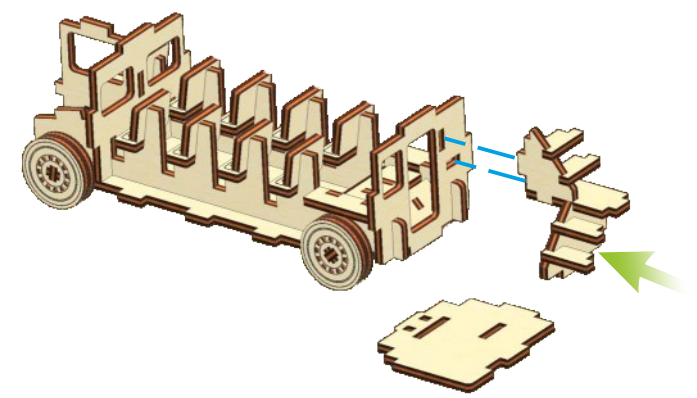
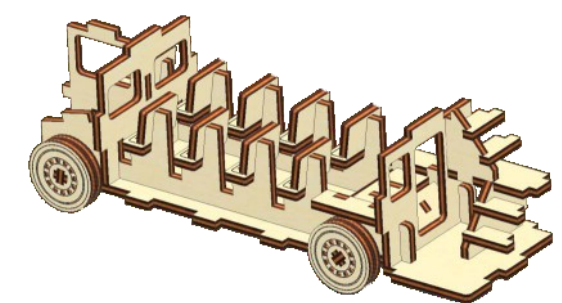
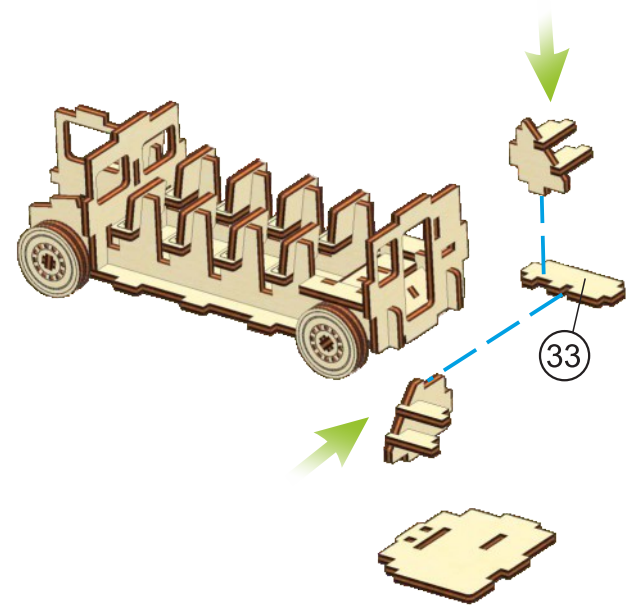
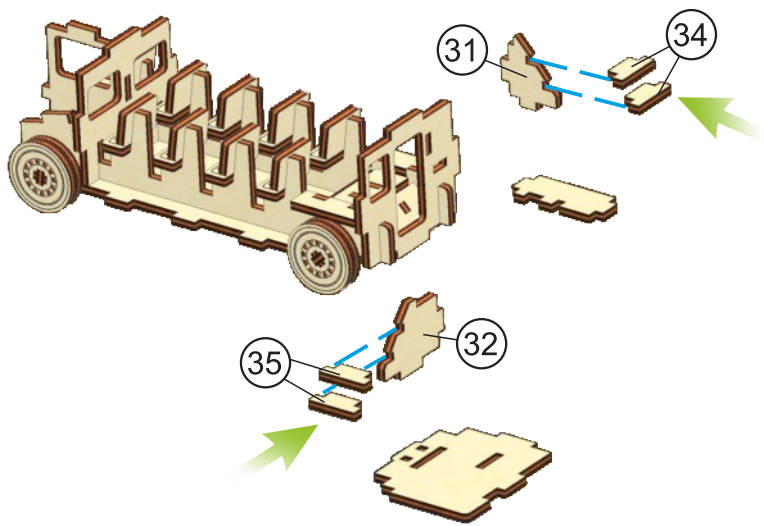

5

